

2040

TRICAN
CORPORATION

 **BAT**
awning the Italian way



2040

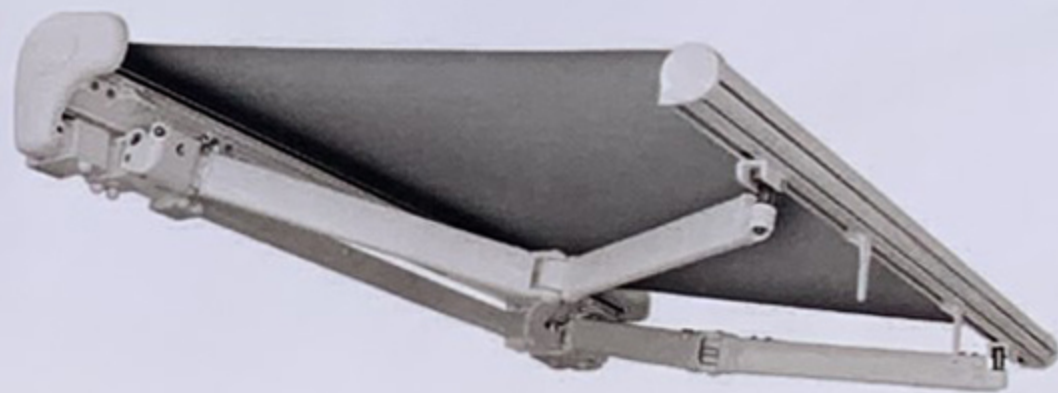

2040 is a folding arm awning on a 40x40 mm zinc plated and painted steel square bar with half cassette and double covered cables or stainless chain arms. This model includes a patented tipping system which allows to adjust the awning's inclination without acting on the cassette itself.

2040 est un store banne à bras extensibles sur barre carrée 40x40 mm en acier zingué et laquée, avec bras à double câble gainé ou chaîne inox avec demie coffre. Le support bras à basculement breveté permet le réglage de l'inclinaison du store sans modifier la position du coffre.

TECHNICAL SHEET

Fiche technique

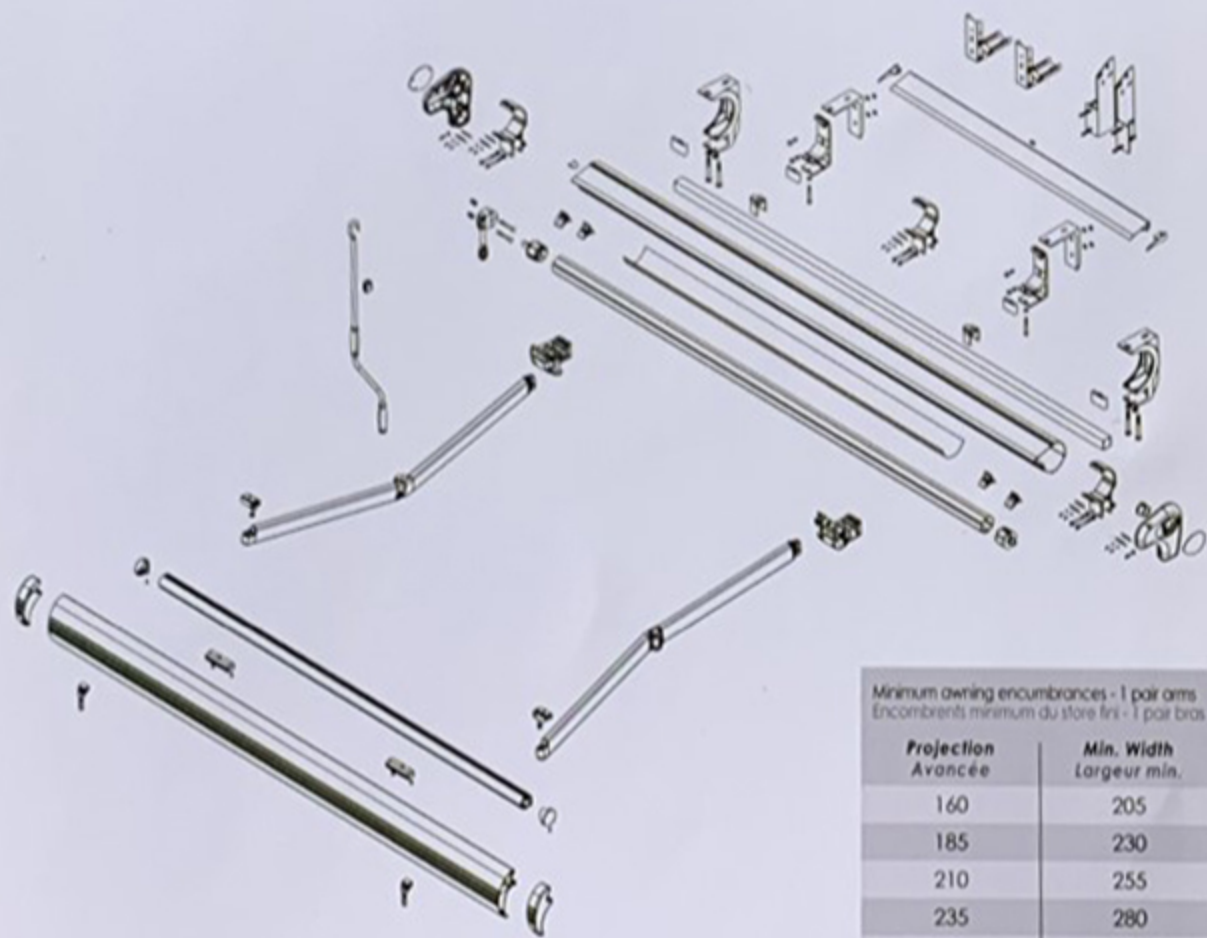
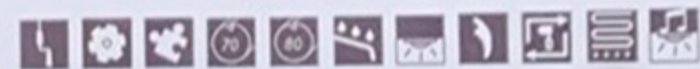

Minimum owing encumbrances - 1 pair arms
Encombres minimum du store fini - 1 par bras

| Projection Avancée | Min. Width Largeur min. |
|-----------------------|----------------------------|
| 160 | 205 |
| 185 | 230 |
| 210 | 255 |
| 235 | 280 |
| 260 | 305 |
| 285 | 330 |
| 310 | 355 |
| 335 | 380 |
| 360 | 405 |

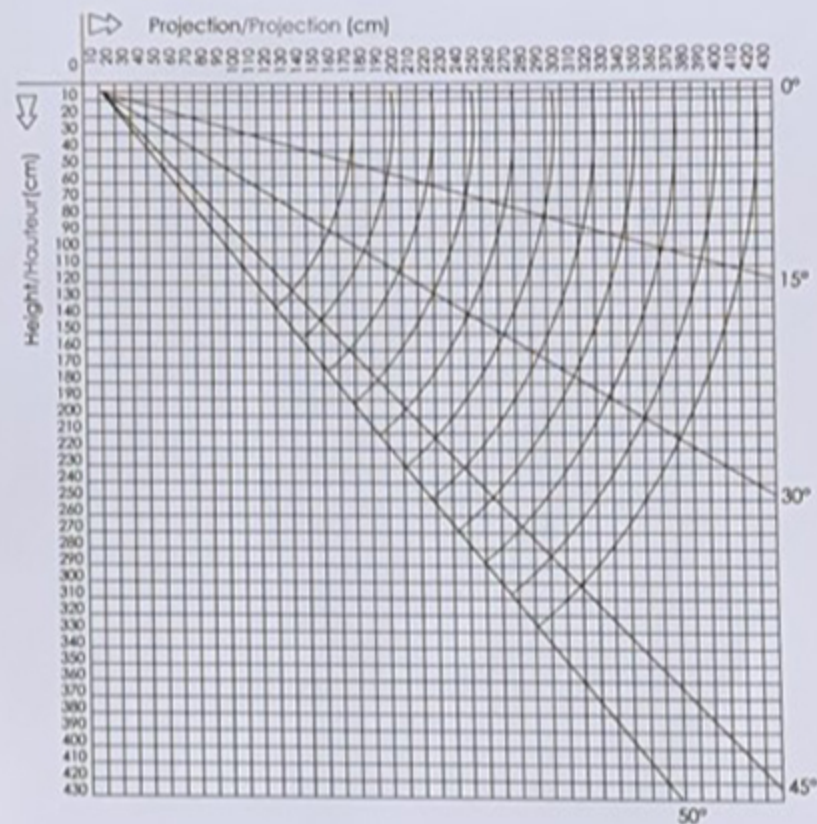

Wall installation
Installation au mur

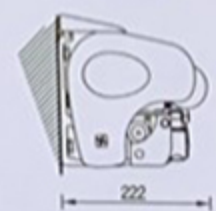

Ceiling installation
Installation au plafond



Wall installation with
31592 terminal bar
Installation au mur avec
barre de charge 31592



Ceiling installation
with 31592 terminal bar
Installation au plafond avec
barre de charge 31592



Under-roof installation
Installation a combie

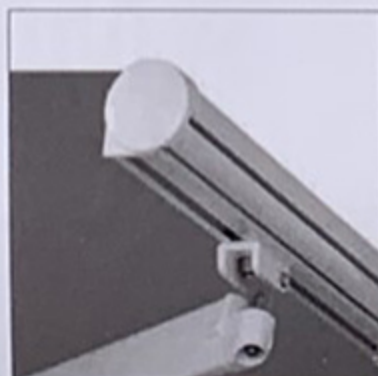
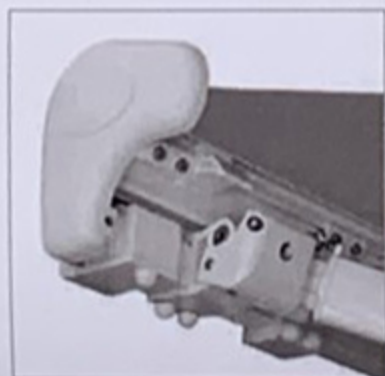



TRICAN
CORPORATION

TRICAN CORPORATION

6200 Danville Road
Mississauga, ON
L5T 2H7
T. 905 795 1525
F. 905 795 1526

